



WWTCFB20

[User Manual]

Please read and follow the installation and operating instructions provided.

Table of Contents

I. Introduction 1

II. Installation Instructions 2

 Step #1 Connect 10' toolbar

 Step #2 Attaching your toolbar to your front bucket

 Step #3 Attaching wings to toolbar

 Step #4 Saturate your sponges

 Step #5 Secure one t-riser to your toolbar

 Step #6 Connecting the sponge section to the t-riser

 Step #7 Secure the rest of your t-risers and sponges

 Step #8 Mounting your manifold

 Step #9 Plumbing your weed wiper

 Step #10 Check valve & filter assembly

 Step #11 Installing the electrical wire harness

III. Operating Instructions 8

 Before You Start

 Mixing Instructions

 Field Adjustments

IV. Maintenance Requirements.....10

 Common Filter Maintenance

 Operating At Freezing Temperatures

IMPORTANT:

YOUR SMUCKER WEED WIPER COMES WITH A 2 YEAR MANUFACTURES WARRANTY. PLEASE SAVE YOUR RECEIPT FOR PROOF OF PURCHASE. CONTACT THE DEALER THAT YOU PURCHASES YOUR WIPER FORM WITH ANY WARRANTY ISSUES.

INTRODUCTION

Congratulations on your purchase of a Smucker Super Sponge® Weed Wiper!

The Super Sponge® is a lightweight, durable, herbicide applicator. Our sponges are designed to apply the maximum amount of product to the target weeds without any drift. The sponge applicators are made of industrial-strength, crusted sponge that stay saturated with chemical to wipe directly onto weeds. Our sponge weed wiper and top crop kits are applicators. Smucker Manufacturing makes no guarantee of any and all chemical use through the sponge application. Please read all chemical labeling concerning the weed wiper instructions.

The Super Sponge® has proven to be a quick and efficient way to wipe out weeds in your crops in many independent studies and we are confident you will be pleased with the results. We value our customers, and we would appreciate any input or comments you may have regarding your new Super Sponge® wiper.

You can visit our smuckermfg.net website page for reference to all weed wiper parts and diagrams. If you still have questions, give us a call and we can even help you locate your closest Smucker dealer.

Also, visit www.smuckermfg.net or ask your dealer about the other product lines we offer. We offer premium products at an affordable price. Take a look at our Foam Markers, Calf Warmers, and VisionWorks camera systems for farm equipment on our website.

www.smuckermfg.net

www.redweeder.com

www.visionworkscameras.com

Scan QR codes below with your smart phone

Mobile website for VisionWorks Cameras



Smucker Mobile website



Installation Instructions

Thank you for purchasing a Front Bucket Weed Wiper. Please follow the directions provided carefully for Front Bucket installation. We recommend assembling this unit with two people. You should expect a 1-1 ½ hour assembly time.

Please refer to your Parts Inventory Sheet when installing your Weed Wiper.

Step #1 Connect the 10' Toolbar

NB3820



NB38LO



NB38NU



Connect the 5' toolbar and 5' toolbar extension together with your extension insert bar as pictured. Use 3/8" x 2" bolts (NB3820 QTY: 4) with a washer and nut (NB38LO QTY: 4, NB38NU QTY: 4) to secure the toolbar and extension to the insert bar.

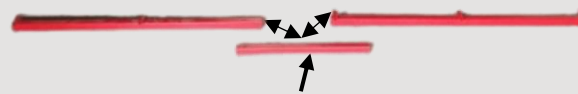

Extension Insert Bar

Step #2 Attaching your toolbar to the front-bucket

NB3825



NB38NU



NB38LO



First, attach your front bucket brackets (WWFB BKT) supplied in this kit. **Make sure you secure them with two 3/8" nuts per bracket (NB38NU).** This will function as a jam nut and secure your wiper to the front bucket.

Attach your 10' toolbar you assembled in step #1 to the front bucket brackets (WWFB BKT) by running the 3/8" x 2 1/2" bolts provided (NB3825 QTY: 4) with the 3/8" lock washers (NB38LO QTY: 4) and 3/8" nuts (NB38NU QTY: 4) through the bracket tabs (WWFBMB-T) as pictured.

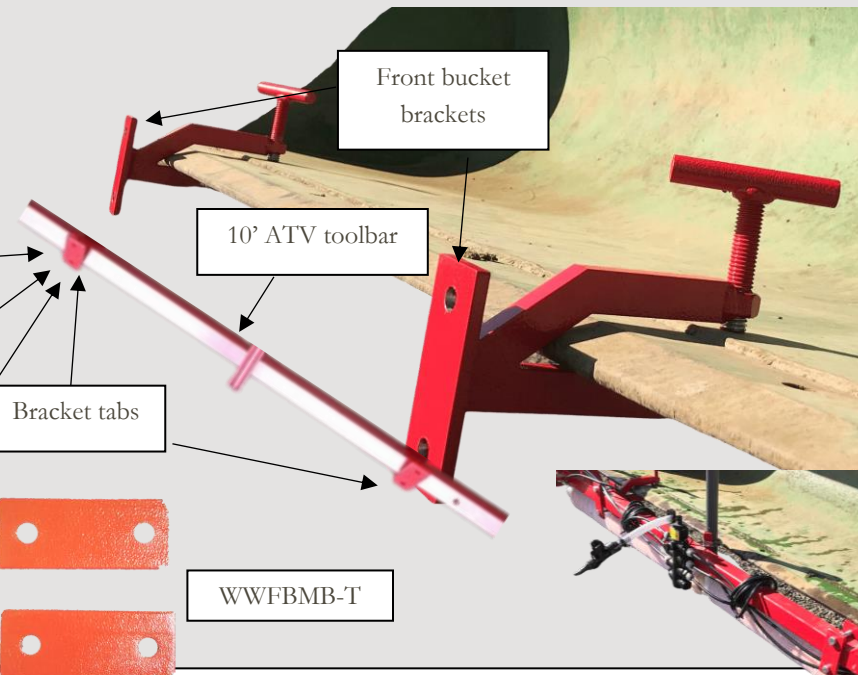

Step #3 Attaching your wings

Grab your 5' wings (WW1411 QTY: 2) and attach your wings to your toolbar assembly. Use the 3/8" x 10" bolt (NB3899 QTY: 2) and the 3/8" Nylok nuts (NB38NI) to attach your wings to your toolbar. Lock your wing into position with your RC Pin (WR4240 QTY: 2). **Be sure to attach them so that your wing angle iron tabs are facing the opposite direction of your toolbar angle iron tabs (see picture).**

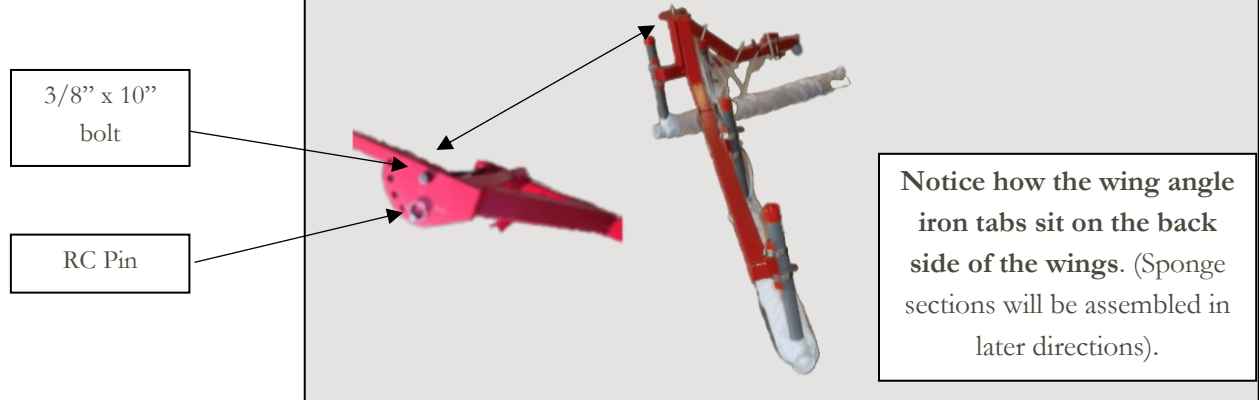

Step #4 Saturate your sponges

Get your sponges wet with a garden hose and then squeeze out excess water. This step will make it a lot easier to move the sponges during assembly.

Step #5 Secure t-riser to your toolbar

Secure one PVC t-riser (WW2346-TC) to the angle irons on the toolbar with two clamps (CL0016). **Moving forward it will be easiest to work from left to right**, when facing your toolbar angle irons, as shown in the photos below. **Make sure the blue line is facing forward in the wiping direction.**

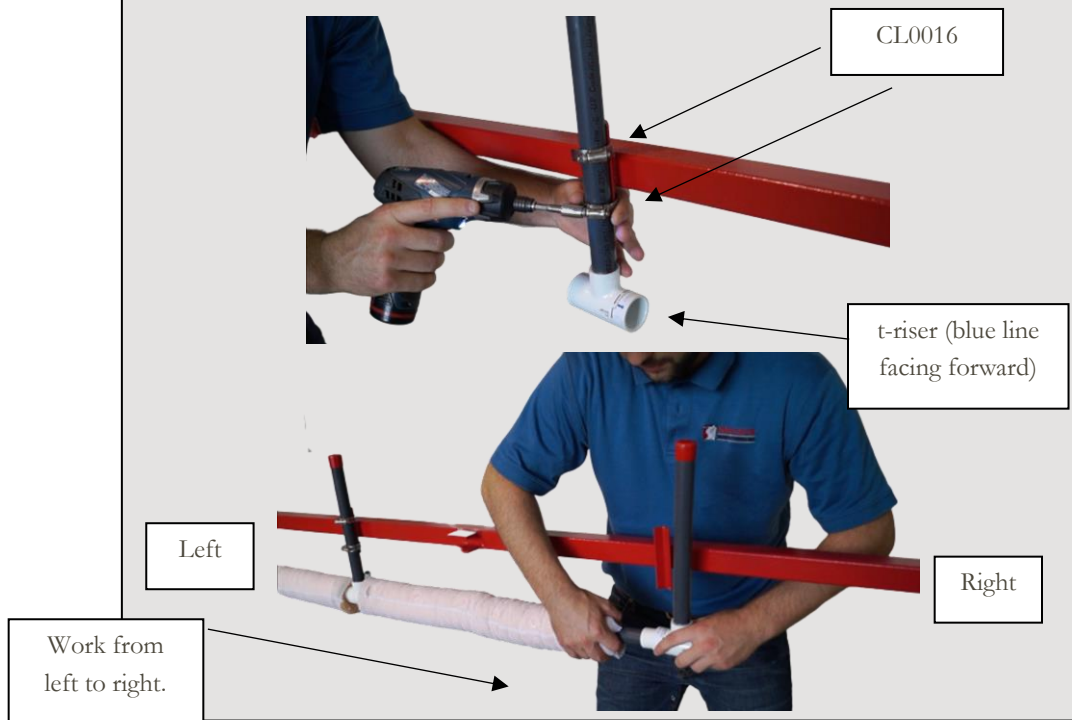

Step #6
Connecting the
sponge section to
the t-riser

Use a mallet hammer to attach a 30” sponge section (WWTC30) to the PVC t-riser (WW2346-TC) you just clamped in and **make sure the blue lines shown below are lined up**. This will ensure that the precision drilled holes on the PVC are angled in the one o’clock position in the wiping direction.

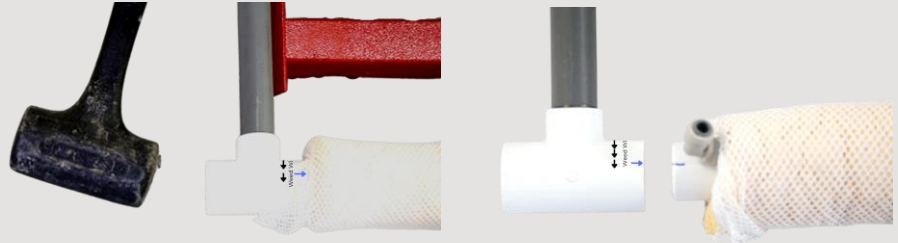

Hammer the sponge white caps into the t-risers **until the edge of the white cap reaches the center of the t-riser**. Remove the red cap after hammering and shine a flashlight through the riser to make sure your cap has reached the center of the t-riser as shown below.

Inside of PVC t-riser when you remove the red cap.

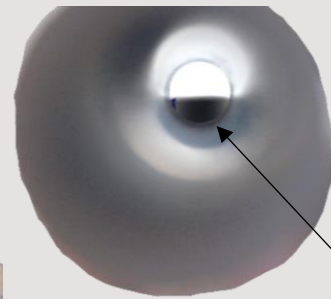
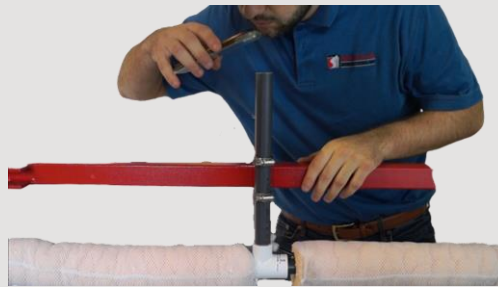

Edge of white cap should be in the center of the t-riser

IMPORTANT: DO NOT glue your sponge sections into your PVC t-risers. You can pull back your sponges to confirm that the precision drilled holes are pointing in the same direction as shown below.

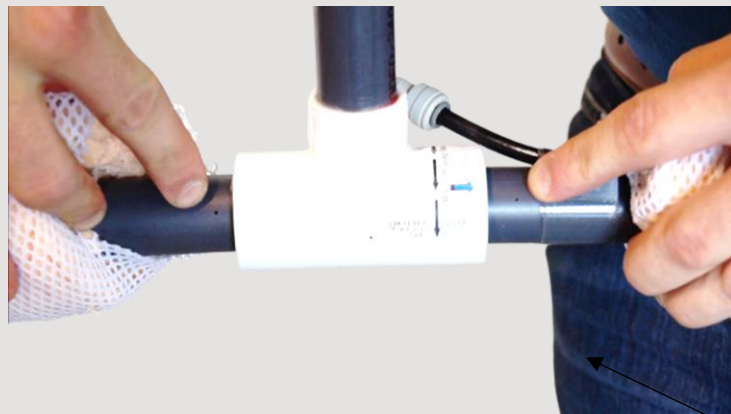

Step #7 Secure the rest of your t-risers and sponges

Working from left to right, repeat steps #5 and #6 until you run out of sponges and t-risers. This unit will have 3 sponge boom sections (5 t-risers and 4 sponges for the toolbar and 3 t-risers and 2 sponges for each wing). Please note that it is okay to end your boom with a t-riser since there is no chemical flow through the t-risers. Make sure all push to connect elbows are facing the same direction.

Push to connect elbow on the same side of sponge

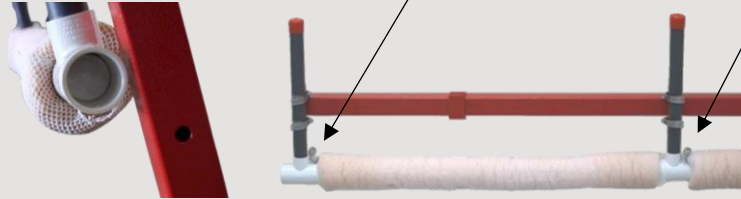

Additionally, make sure that you clamp each t-riser at the same height to ensure that your sponge boom is level. After finishing these steps, make sure you stretch your sponge out over the t-risers so that your boom is almost entirely covered by your sponges.

Notice the t-risers are attached in the same spot to ensure a level sponge boom.

Stretch sponges out over the t-risers



Step #8 Mounting your manifold

Your kit comes with a manifold system (WWTCM8P) which connects to the tank's pump. First, mount the manifold to the **CENTER** of your boom frame (i.e. the center of your weed wiper) with the zip ties provided. **If you do not mount to the center of your boom frame, the tubing included in this kit will not reach all your sponges.**



Find the center of your 20 ft. boom. Zip tie it in a secure position. Note pictured position may not be your center. The picture is only meant for visual reference of a secure position. Also please note the manifold pictured above is a 6-port and yours is an 8 port.

Step #9 Plumbing your weed wiper

Run the 3/8" vinyl tubing (**not provided**) needed from your pump (**not provided**) on your tank (**not provided**) to the manifold and use the 9/16" (CL0916) clamp to secure the tubing. As you run the vinyl tubing out to your check valve on your manifolds, coil up the tubing when necessary and secure the tubing with the 9/16" clamp.



The manifold included has quick connectors to supply product to each of the 30" sponge section (in this case there are 8 ports). Measure your longest line and cut your WW1215 roll in equal lengths, to plumb from your manifold to your individual sponge sections. **It is extremely important that each sponge assembly is supplied with the same length of tubing to ensure equal chemical flow.**



Coil your excess tubing around your boom. Secure with zip ties

Simply push the tubing into the quick connectors on both your sponge section, and your manifold (as shown above). Any extra tubing can be coiled up and zip tied down to the boom. Do not over tighten the zip ties and pinch the tubing. **The manifold pictured below is a 4-port manifold, your manifold is a 8-port manifold.**

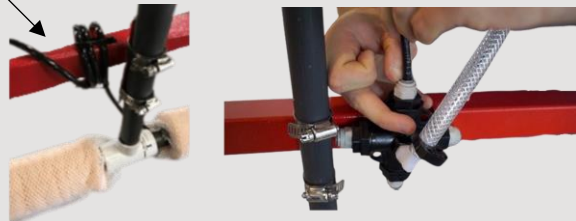

To remove the tubing **hold down the grey ring around push to connect, while pulling out the tubing.**

Step #10 Check valve & filter assembly

To Weed Wiper

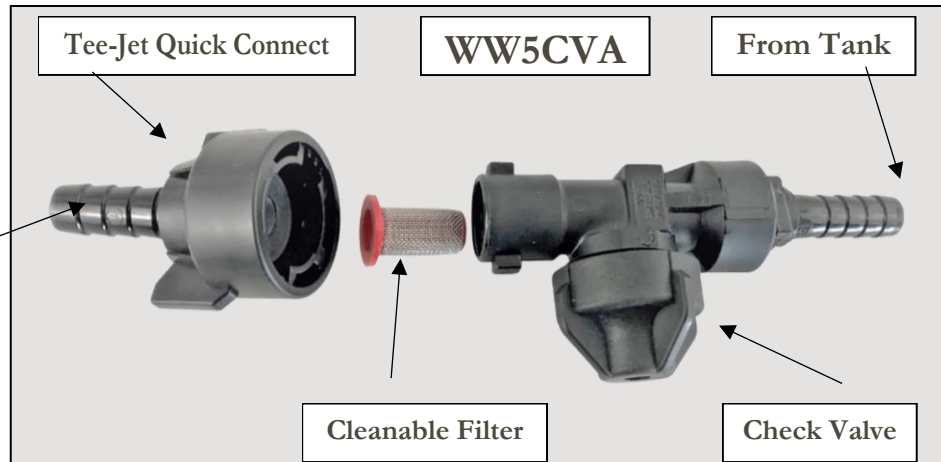

This assembly comes pre-installed to the inlet side of the manifold.

Make sure that you have a way to turn the pump on and off. You will not be running the pump continuously while using your weed wiper. When the pump is on, chemical will be pumped into the PVC, then through small holes saturating the sponges. This pump fed system will ensure quick filling and instant shut off since the system is pressurized.

Maintenance/Winterization

We recommend routinely checking your cleanable filter. The holes feeding the sponges are very small, they can plug easily without a functioning filter. When you **WINTERIZE** your wiper, remove your tee-jet quick connect and blow shop air toward the sponges to remove any residual liquids.

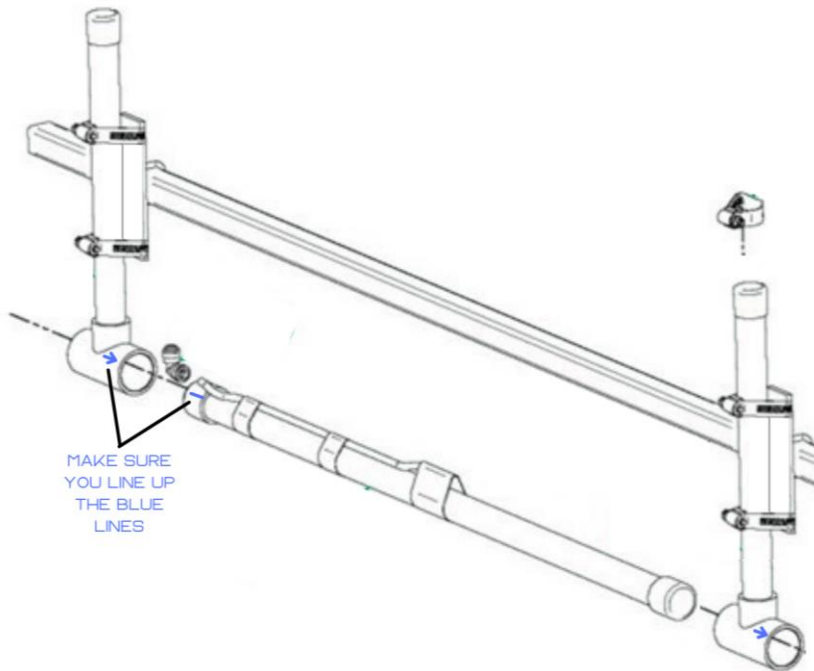

Step #11 Installing the electrical wire harness

Install the wire harness (SPS117) according to the instructions included with the wire harness. Then, mount the switch in a position that can be reached by the operator.

When the pump is on, the chemical will be pumped into the PVC, through small holes, and into the sponge. This pump fed system will ensure quick filling of the sponges and instant shut off when the switch is turned off.

Operating Instructions

The Weed Wiper is a very effective contact herbicide applicator. Non-selective herbicides can be applied to weeds growing above crops. Proper set-up, adjustment, operation, and maintenance are essential to assure effective weed control while protecting the crop from herbicide damage.

Before You Start

1. Before you start using your sponge weed wiper in the field, get the sponges wet with a garden hose. When sponges are dry, they are hard and do not absorb chemical evenly.
 2. Next, we recommend that you run water through your tank to check your sponges for even feeding. Before filling the tank with chemicals, put water in your tank and turn on the pump until you see the sponges dripping. Watch for even dripping throughout the full length of the boom. Unlike a conventional sprayer, you cannot see plugged nozzles on a wiper during operation. Always check for uniform feeding before heading out into the field.
 3. Once even feeding is attained, drain your product tank by removing the 3/8" supply tubing from the check valve assembly. Run your pump till the tank is empty. Squeeze the excess water from the sponges and fill the tank with chemical solution. Turn on your pump until you see the sponges fully saturated (almost dripping), which typically will only take a few seconds. Once your sponges are saturated, you are ready to go weed wiping!
-

Mixing Instructions

The most common product to use in a wiper is Glyphosate. The manufacturing label recommends a 33% mix rate, however, please follow **your** label for mix rates in a wiping applicator/contact herbicide applicator. It is important to remember that the ratio of herbicide to water can vary depending on the weeds to be controlled, the time of year, and the temperature. Contact your chemical field representative or extension service for the best herbicide mix rates and proper surfactants to kill the weeds you are trying to control.

If you are trying to control Glyphosate resistance weeds, you may want to consider using Paraquat. The label, in most states for controlling Palmer Amaranth, is listed at a 50% mix rate.

Field Adjustments

Adjust the height of the sponges to a level just above crop to contact as much of the weed as possible, without wiping the crop.

Turn on the master on/off switch only when you believe that you need more chemical, the sponges should fill within a few second. Begin wiping at 5-7 MPH. Try to maintain a proper level of product in the sponges without dripping. While you are learning the timing for turning the pump on and off, it's usually better to set the wiper too wet and have a little dripping, rather than have it set too dry and have poor weed kill.

Maintenance Requirements

Common Sponge Maintenance

The protective netting over the sponge is easy to replace. Therefore, we recommend that you check your sponges often for wear and tear.

If you need your netting replaced, ask us for part number (WW2302). If you need your sponge replaced, ask us for part number (WW2301).

Storage Maintenance

Do not store the system over the off-season with chemical in the lines. A film will form on the tubing and can plug the small feedholes within the sponge. Avoid this by flushing your system thoroughly with water at the end of the season. We recommend using a garden hose to rinse the bulk material out of the sponges after every use.

Check and clean the filter within the check valve assembly as needed. At the end of the season, store your weed wiper in a dry place, **out of direct sunlight**.
