



WWTCATV10

[User Manual]

Please read and follow the installation and operating instructions provided.

Table of Contents

- I. Introduction 1
- II. Installation Instructions 2
 - Step #1 Lay out your frame
 - Step #2 Connect your 10 ft. toolbar
 - Step #3 Connect your Mounting Bracket to your toolbar
 - Step #4 Connect Toolbar Assembly to Mounting Brackets
 - Step #5 Attach assembly to desired equipment
 - Step #6 Connecting the Sponge Sections
 - Step # 7 Attaching your boom
 - Step # 8 Plumbing and Manifold options
 - Step # 9 Quick Disconnect, Check Valve & Filter Assembly
- III. Operating Instructions10
 - Before You Start
 - Mixing Instructions
 - Field Adjustments
- IV. Maintenance Requirements.....12
 - Common Filter Maintenance
 - Operating At Freezing Temperatures
- V. Policies and Information13

IMPORTANT:

YOUR SMUCKER WEED WIPER COMES WITH A 2 YEAR MANUFACTURES WARRANTY. PLEASE SAVE YOUR RECEIPT FOR PROOF OF PURCHASE. CONTACT THE DEALER THAT YOU PURCHASES YOUR WIPER FORM WITH ANY WARRANTY ISSUES.

INTRODUCTION

Congratulations on your purchase of a Smucker Super Sponge® Weed Wiper!

The Super Sponge® is a lightweight, durable, herbicide applicator. Our sponges are designed to apply the maximum amount of product to the target weeds without any drift. The sponge applicators are made of industrial-strength, crusted sponge that stay saturated with chemical to wipe directly onto weeds. Our sponge weed wiper and top crop kits are applicators. Smucker Manufacturing makes no guarantee of any and all chemical use through the sponge application. Please read all chemical labeling concerning the weed wiper instructions.

The Super Sponge® has proven to be a quick and efficient way to wipe out weeds in your crops in many independent studies and we are confident you will be pleased with the results. We value our customers, and we would appreciate any input or comments you may have regarding your new Super Sponge® wiper.

You can visit our smuckermfg.net website page for reference to all weed wiper parts and diagrams. If you still have questions, give us a call and we can even help you locate your closest Smucker dealer.

Also, visit www.smuckermfg.net or ask your dealer about the other product lines we offer. We offer premium products at an affordable price. Take a look at our Foam Markers, Calf Warmers, and VisionWorks camera systems for farm equipment on our website.

www.smuckermfg.net

www.redweeder.com

www.visionworkscameras.com

Scan QR codes below with your smart phone

Mobile website for VisionWorks Cameras



Smucker Mobile website



Installation Instructions

Thank you for purchasing an ATV Weed Wiper. Please follow the directions provided carefully. We recommend assembling this unit with two people. You should expect a 1-1 1/2 hours assembly time.

Please refer to your Parts Inventory Sheet when installing your Weed Wiper.

Step #1 Lay out your frame

Your ATV Weed Wiper can be mounted on the front rack of your ATV, on the front of your UTV, or on your front bucket of a tractor. Pull out your ATV weed wiper parts and follow the directions below.

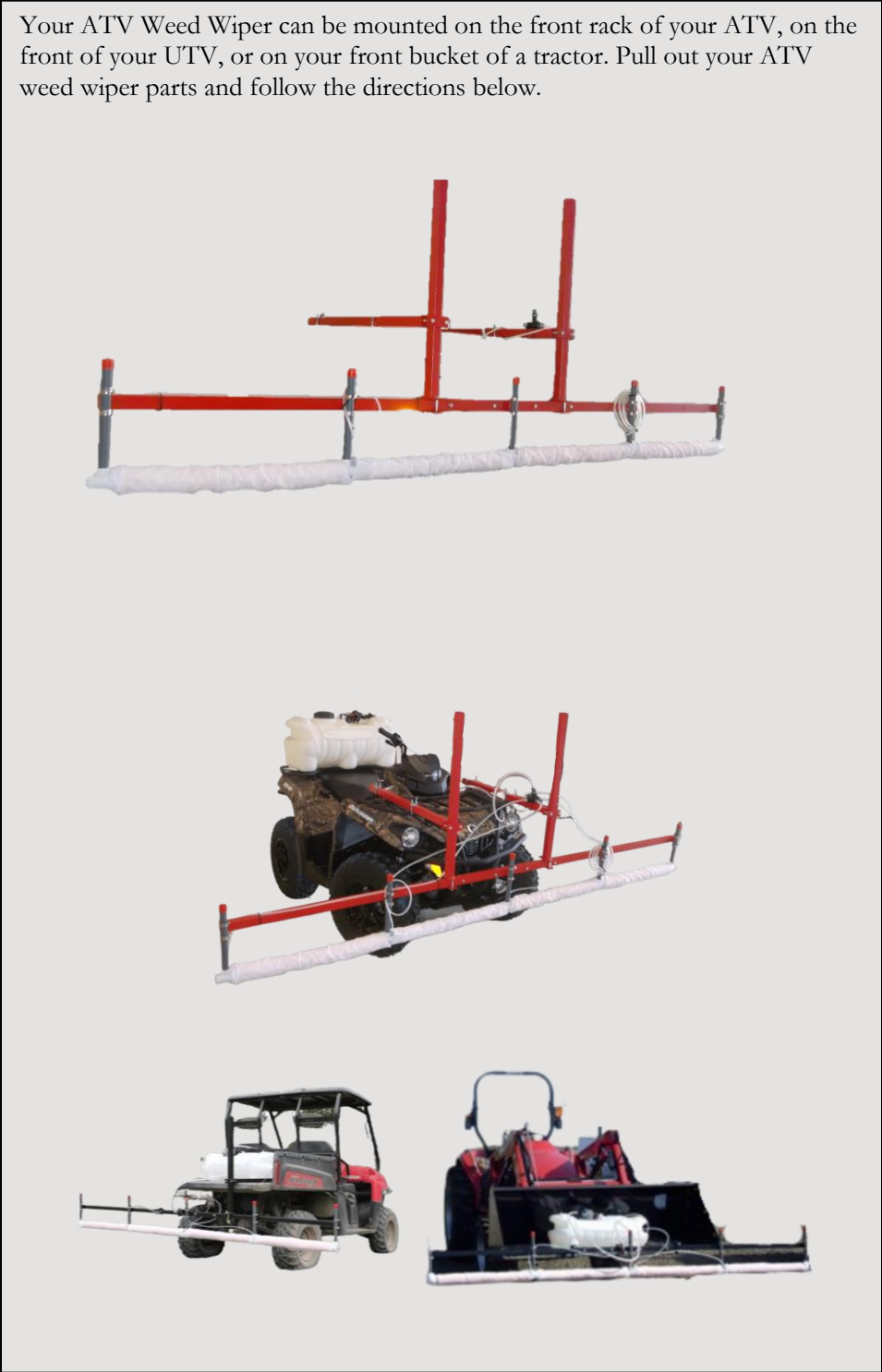

Step #2 Connect your 10' toolbar

NB3820



NB38LO



NB38NU



Connect your 5 ft. toolbar (WWFBTB) and 5 ft. toolbar extension (WWFBTB-E) together with your extension insert bar (WWFBTB-EI). Use 3/8" x 2" bolts (NB3820 QTY: 4) with a washer and nut (NB38LO QTY: 4) NB38NU QTY: 4) to secure the toolbar and extension to the insert bar.



Extension Insert

Step #3 Connect your Mounting Bracket to your toolbar

NB3825



NB38LO



NB38NU



Attach two 33" mounting brackets (WWFBMB-D) to your toolbar as pictured, using the brackets tabs (WWFBMB-T) and the 3/8" x 2 1/2" bolts provided (NB3825 QTY: 4) with the 3/8" lock washers (NB38LO QTY: 4) and 3/8" nuts (NB38NU QTY: 4). **Note: The metal bracket tabs pictured are not connected to your existing toolbar.**

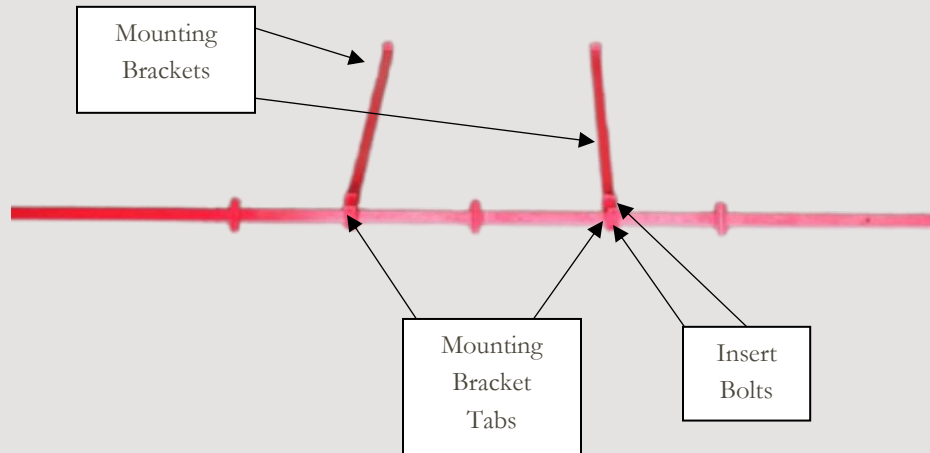

**Step #4 Connect
Toolbar Assembly
to Your Mounting
Brackets**

NB3825



NB38NU



NB38LO



Attach your remaining brackets at your desired height for wiping. You can always loosen the bolts and adjust your height later.

Attach your remaining two 33" mounting brackets (WWFBMB-D) to your bracket assembly as pictured, using the remaining bracket tabs (WWFBMB-T QTY: 2) and the 3/8" x 2 1/2" bolts provided (NB3825 QTY: 4) with the 3/8" lock washers (NB38LO QTY: 4) and 3/8" nuts (NB38NU QTY: 4).

Option #1 for ATV or UTV

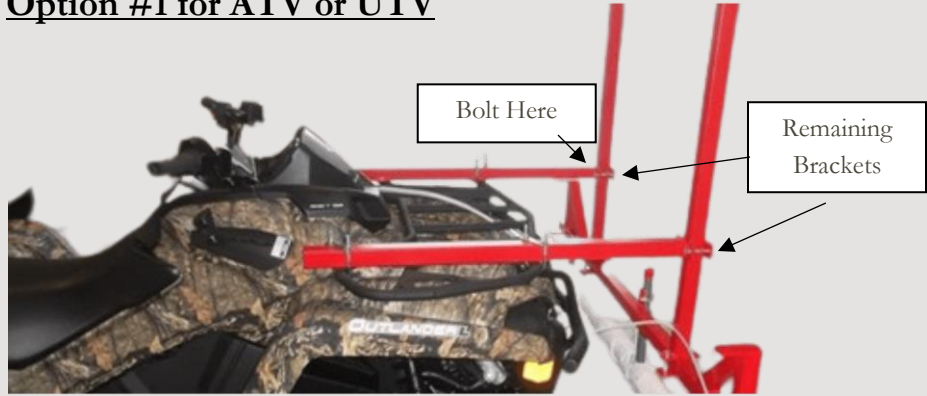

Option #2 for Front Bucket Mount

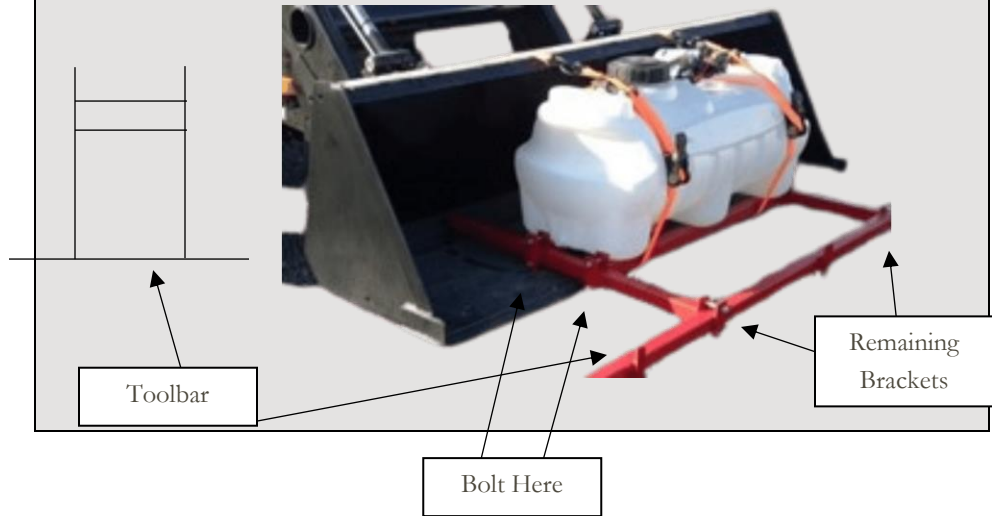

**Step #5 Attach
Assembly to your
desired equipment**

Option #1 Attach to your ATV

Use the U-Bolts provided (NBUB07 QTY: 4) to attach your toolbar to your ATV rack as pictured. Use two U-bolts on each metal bar.

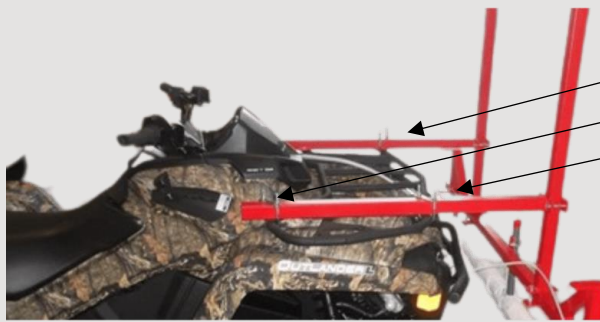

Option #2 Attach to your UTV

You may choose to mount your toolbar to the front bumper of a UTV. To do this, you will need the UTV mounting bracket. (see pictures below). Please contact us for questions on this option.



Option #3 Attach to your front bucket

You may choose to mount your toolbar to your front bucket on your tractor. If you choose to do this, you can drill a hole in your front bucket and use the U-bolts (NBUB07 QTY: 4) to mount your toolbar directly to your bucket. Or ask us about our Front Bucket Mounting Brackets.



Step #6 Connecting the Sponge Sections

The first step is to lay out each of the 30" sponge sections (WWTC30 QTY: 4) Connect them together as pictured with our PVC, "Tee" risers (WW2346-TC QTY: 5). **Do not worry, it is okay to end your boom with a "Tee" since there is no chemical flow through the risers.**

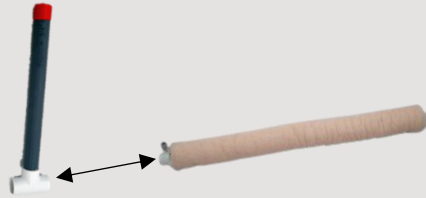

IMPORTANT: DO NOT glue your sponge sections into your PVC "Tees." Hammer them together with a mallet (as shown in the picture below). It's **very important** that you connect your sponge sections with the push to connect elbow facing up (as pictured) with the blue mark on your white caps facing forward from your boom, in the direction you will wipe, at the one o'clock position (as pictured). **Notice that your push to connect elbow will be on the same side for each of your sponges across your boom** (as pictured next page).

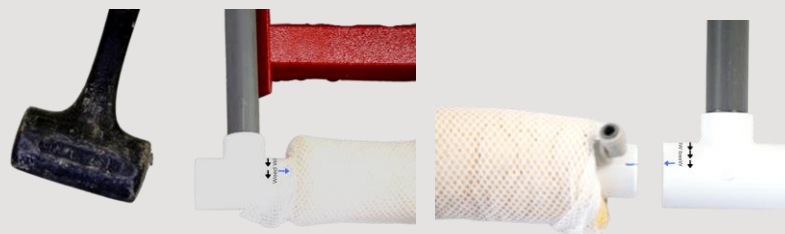

Push to Connect Elbow on the Same Side of Sponge

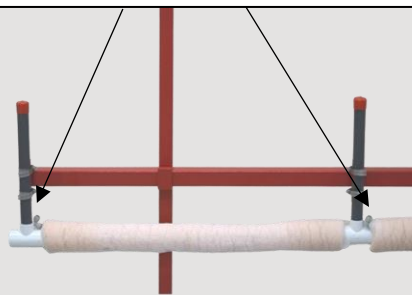

Make sure, as you hammer in your elbow, that you get your sponge wet and hammer the elbow in until the edge of the cap reaches the center of the, "Tee." After hammering in your risers, make sure you stretch your sponges out over your T-risers so that your boom is almost entirely covered by your sponges (Sponges must be wet to do this).

Step #7 Attaching your boom

From there simply clamp your, "Tee" riser onto the metal angle iron tabs with the clamps included CL0016 (QTY: 10). Make sure that you clamp each, "Tee" riser at the same height to ensure that your sponge boom is level (as pictured next page). Use two clamps per riser.

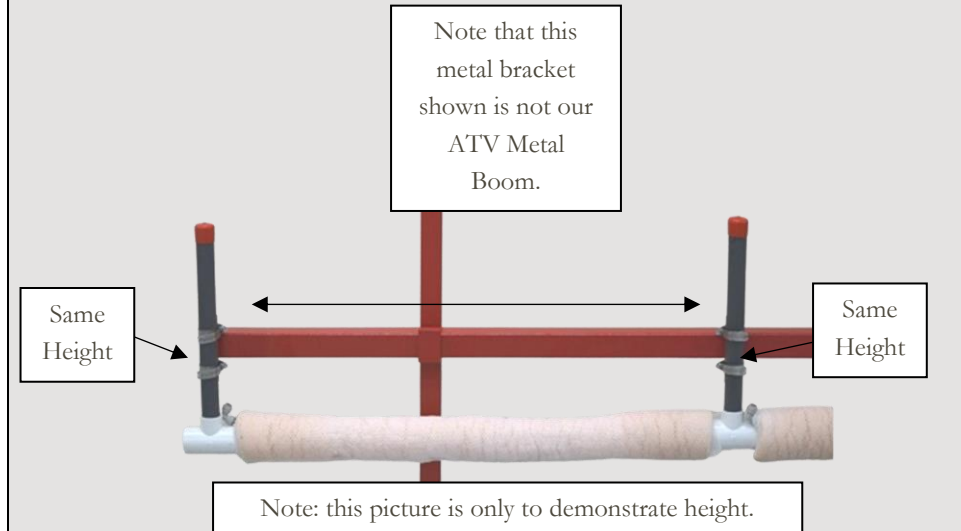

Step #8 Plumbing and Manifold Options

Your kit comes with a manifold system (WWTCM4P), which connects to your existing (not provided) equipment pump outlet. Mount the provided manifold (WWTCM4P) to the **CENTER** of your boom. (i.e. the center of your weed wiper), with the zip ties provided (NY108H)

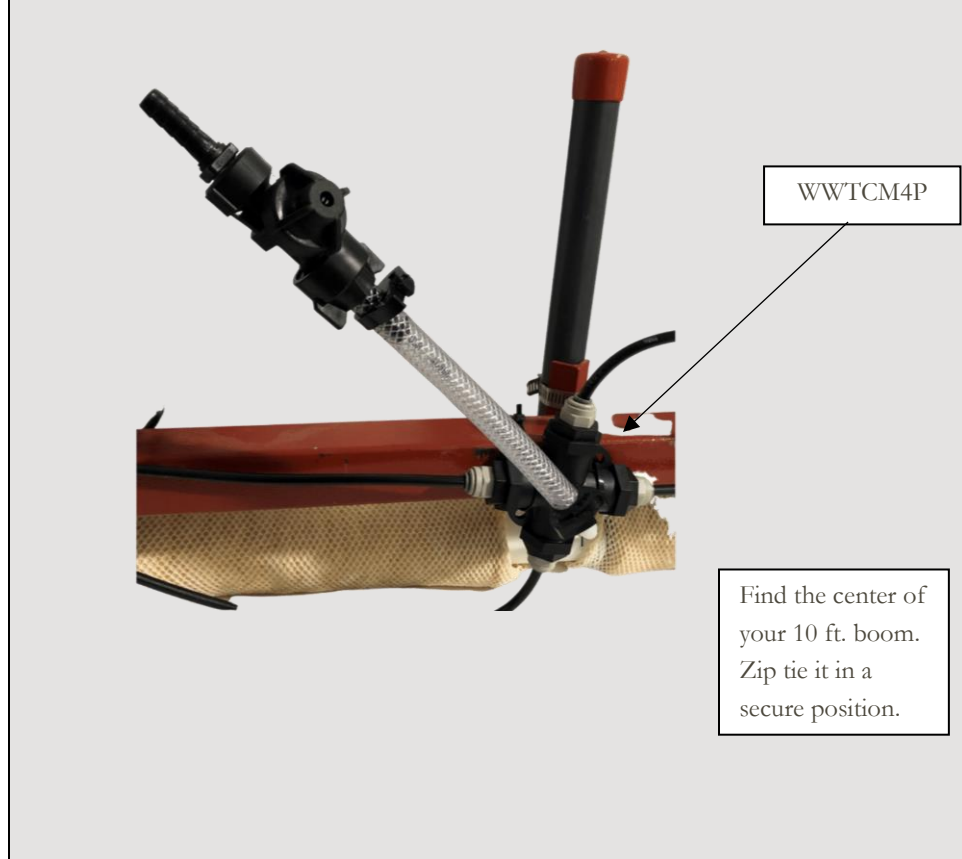

(Step #8 continued)

We **DO NOT** provide the pump needed to power your weed wiper. We recommend using a minimum 1.8 GPM per minute pump. We also **DO NOT** provide the vinyl tubing needed to run from your manifold to your pump because the length required will vary. Now, connect your manifold to the outlet on your spray pump.



The manifold included has 4 quick connectors to supply product to each of the 30” sponge section. Be sure that the manifold is mounted in the center of your boom. **It is extremely important that each sponge assembly is supplied with the same length of tubing to ensure equal chemical flow.** Any extra tubing can be coiled up on the boom. Do not over tighten the zip ties and pinch the tubing.

Simply push the tubing into the quick connectors on both your sponge section, and your manifold. To remove the tubing, hold down the grey ring around the push to connect, while pulling out the tubing

Coil your excess tubing around your boom. Secure with zip ties



Step #9 Quick Disconnect, Check Valve and Filter Assembly

To Weed Wiper

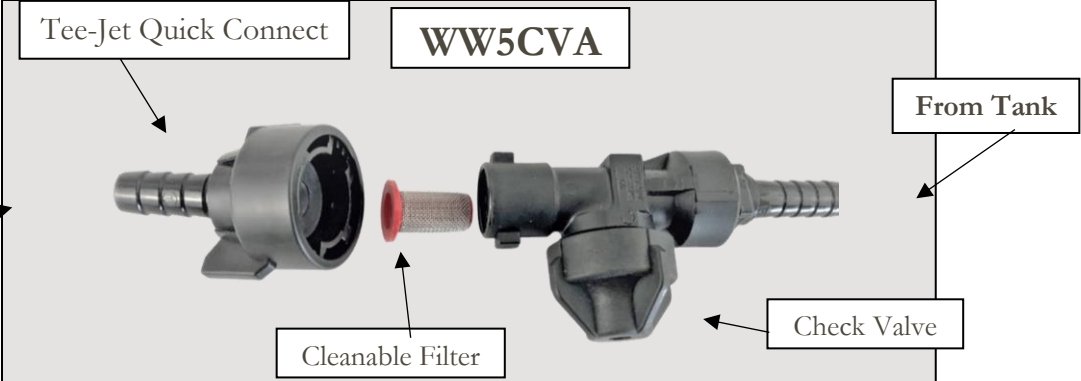

Tee-Jet Quick Connect **WW5CVA**

From Tank

Cleanable Filter

Check Valve

This assembly comes pre-installed to the inlet side of the manifold. Make sure that you have a way to turn the pump on and off. You will not be running the pump continuously while using your weed wiper. When the pump is on, chemical will be pumped into the PVC, then through small holes saturating the sponges. This pump fed system will ensure quick filling and instant shut off since the system is pressurized.

Quick Connect

There is an extra Tee-Jet Quick Connect in the parts bag. The purpose of this extra quick connect is to attach it to the line feeding your sprayer boom or spot sprayer wand. This allows you to quickly switch back and forth between weed wiping and spraying.

Maintenance/Winterization

We recommend routinely checking your cleanable filter. The holes feeding the sponges are very small, they can plug easily without a functioning filter. When you **WINTERIZE** your wiper, remove your tee-jet quick connect and blow shop air toward the sponges to remove any residual liquids.

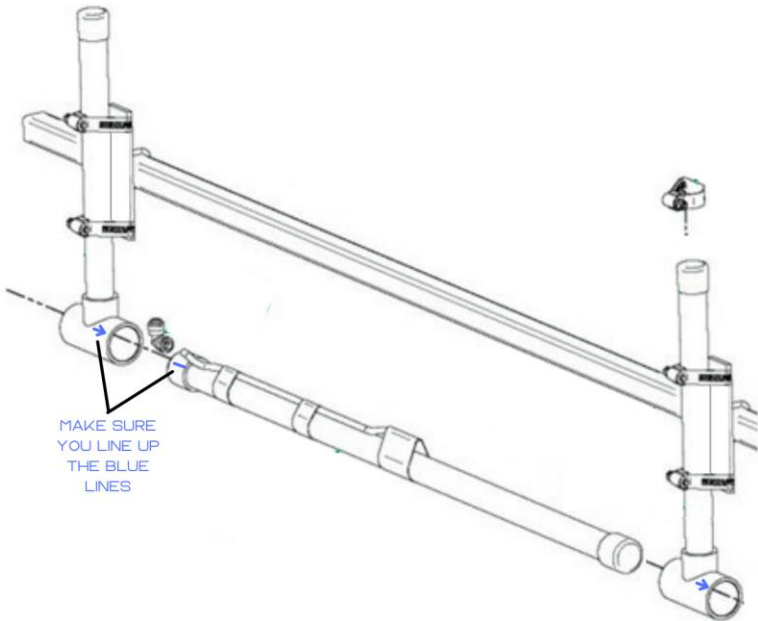

Operating Instructions

The ATV Weed Wiper is a very effective contact herbicide applicator. Non-selective herbicides can be applied to weeds growing above the crop. Proper set-up, operation, and maintenance are essential to assure effective weed control while protecting the crop from herbicide damage.

Before You Start

1. Before you start using your sponge weed wiper in the field, get the sponges wet with a garden hose. When sponges are dry, they are hard and do not absorb chemical evenly.
 2. Next, we recommend that you run water through your tank to check your sponges for even feeding. Before filling the tank with chemicals, put water in your tank and turn on the pump until you see the sponges dripping. Watch for even dripping throughout the full length of the boom. Unlike a conventional sprayer, you cannot see plugged nozzles on a wiper during operation. Always check for uniform feeding before heading out into the field.
 3. Once even feeding is attained, drain your product tank by removing the 3/8" supply tubing from the check valve assembly. Run your pump until the tank is empty. Squeeze the excess water from the sponges and fill the tank with chemical solution. Turn on your pump until you see the sponges fully saturated (almost dripping), which typically will only take a few seconds. Once your sponges are saturated, you are ready to go weed wiping!
-

Mixing Instructions

The most common product to use in a wiper is Glyphosate. The manufacturing label recommends a 33% mix rate, however, please follow **your** label for mix rates in a wiping applicator/contact herbicide applicator. It is important to remember that the ratio of herbicide to water can vary depending on the weeds to be controlled, the time of year, and the temperature. Contact your chemical field representative or extension service for the best herbicide mix rates and proper surfactants to kill the weeds you are trying to control.

If you are trying to control Glyphosate resistance weeds, you may want to consider using Paraquat. The label, in most states for controlling Palmer Amaranth, is listed at a 50% mix rate.

Field Adjustments

Adjust the height of the sponges to a level just above crop to contact as much of the weed as possible, without wiping the crop.

Turn on the master on/off switch only when you believe that you need more chemical, the sponges should fill within a few second. Begin wiping at 5-7 MPH. Try to maintain a proper level of product in the sponges without dripping. While you are learning the timing for turning the pump on and off, it's usually better to set the wiper too wet and have a little dripping, rather than have it set too dry and have poor weed kill.

Maintenance Requirements

Common Sponge Maintenance

The protective netting over the sponge is easy to replace. Therefore, we recommend that you check your sponges often for wear and tear.

If you need your netting replaced, ask us for part number (WW2302). If you need your sponge replaced, ask us for part number (WW2301).

Storage Maintenance

Do not store the system over the off-season with chemical in the lines. A film will form on the tubing and can plug the small feedholes within the sponge. Avoid this by flushing your system thoroughly with water at the end of the season. We recommend using a garden hose to rinse the bulk material out of the sponges after every use.

Check and clean the filter within the check valve assembly as needed. At the end of the season, store your weed wiper in a dry place, **out of direct sunlight.**